



**PRODUCT
INFORMATION GUIDE**

OILMEC DRILLING EQUIPMENTS PVT. LTD.



TABLE OF CONTENTS

1 - Company Introduction

Health & Safety, Oilmec Products Information / Certifications

2 - Reamer & Guide Shoes

Prob-O-Tor Reamer Shoe.

3 - Float Equipment & Cementing Stage Tools

Float Shoe, Float Collar, Stage Tools

4 - Cementing Plugs

Top & Bottom Cementing Plugs

5. Casing Bow Centralizers

Hinge Non weld, Hinge Welded, Slip on Welded

6. Zinc Alloy Solid Body Centralizers

Aluminium, Zinc, Steel

7. Stop Collors

Hinge Spiral, Hinge Bolted, Hinge Set Screw, Slip on Set Screw

8. Float Equipment

9. Services

Research & Design, Solid Works

10. Contact Informaion

Global Offices & Contact Information



HSE Policy

Oilmec is committed to achieve organizational excellence as global composite village by integrating continual innovative improvements in all business processes including Quality, Health, Safety & Environmental protection.

Oilmec aims to achieve corporate sustainability having focus on customer delightness & enhance Health, Safety, Environmental aspects for all employees, contractors & surrounding community.

Oilmec is committed to,

- Integrate this policy throughout all activities from life cycle perspective
- Continually improve HSE by carrying out potential risk assessment, waste minimization & Optimized use of resources through three "R" concept (i.e. recovery, reuse & recycle)
- Provide safe workplaces by identifying, eliminating or mitigating hazards and occupational risks
- Take appropriate actions to faster employees health, prevent all unsafe incidents & adverse environmental impact
- Comply the required standards, procedures, contingency measures, statutory & regulatory requirements and management systems in order to ensure our operations are managed safety, ecologically and in a sustainable manner
- Put concentrated efforts to impart requisite knowledge, skills & training to all employees including contractors as well as interested parties to continuously innovate and improve the HSE systems, processes & products
- Share HSE best practices across the company & Monitor emerging issues and keep abreast of regulatory changes, technological innovations, and stakeholder interests.
- To review, update periodically & communicate to all employees, contractors and interested parties about the policy objectives and HSE performances
- The QHSE policy will be integrated at all levels and is the responsibility of management with the active support of all our staff.



Company Profile

Oilmec is one of the worlds leading manufacturers of cementing products in the world and offers a complete line of both welded and non-welded Bow Centralizers, Float Equipments and other accessories for Oil and Gas Drilling Industry. These product design and manufacturing expertise has been developed by experience, field knowledge & exposure to the technology throughout the world.

Oilmec products are designed, assembled, tested and inspected by its facility which is equipped with modern machines and testing equipment including heat treatment, state of art press shop, machine shop, paint shop and are manufactured with Rigid Quality Control. Quality Management Systems are fully practiced and adhered to as per API Specification Q1 and ISO 9001 – 2015.

Oilmec calculates the total load on centralizer at each deflection and prepares a Load Deflection Curve using arithmetic average of force readings. This determine the Restoring force specified in the API 10D spec.

In addition to API testing Oilmec also perform the following test considering extreme conditions which these product may encounter. Tensile Stress test on these Centralizers is done to ensure that even a severely damaged Centralizer will remain intact rather than damage the completion process and the Compression test are conducted to ensure that even badly distorted centralizer bows will not fracture and leave metal fragments in the well.

Oilmec philosophy is to provide best possible solution to any centralizing problem. As adequate planning and engineering is critical for the success of any cementing job. Good Centralization is necessary to obtain good mud removal which is only achievable by correct selection of the Centralizers and their installation pattern.

www.oilmecasia.com



Strategic Goal

We continue to grow and develop our high quality and innovative brand into the global oil & gas sector. Our focus remains with innovation, collaboration, proactiveness and of course our renowned reliability.

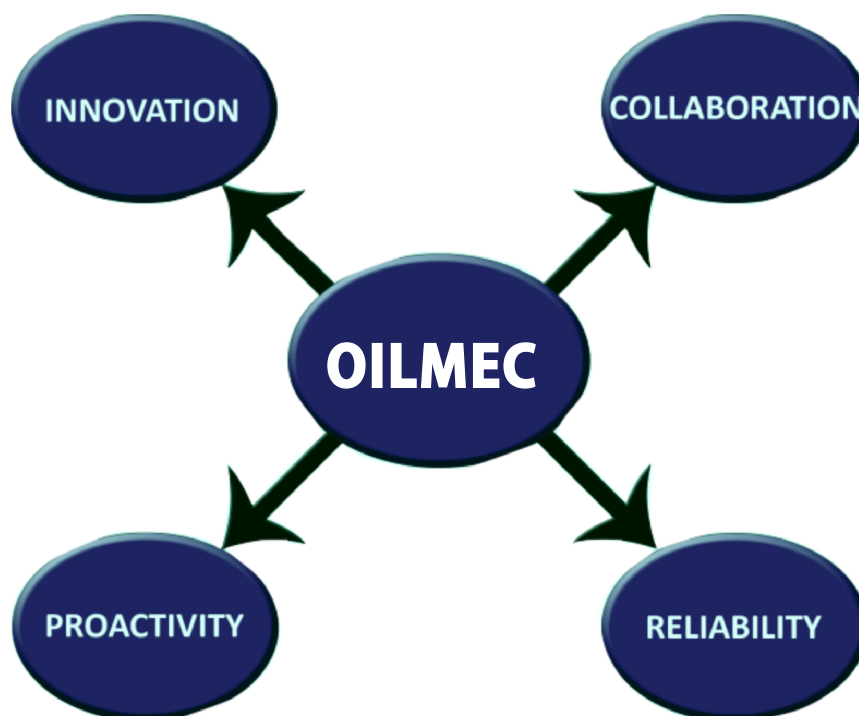

Our commitment to Quality and to our Customers

"To deliver the best value to our customers and markets by finding the optimum balance of performance, quality and price, which in turn will result in the most effective solution to their completion requirements"

www.oilmecasia.com



Certifications





Certificate of Authority to use the Official API Monogram
License Number: 5CT-1666 **ORIGINAL**

The American Petroleum Institute hereby grants to

OILMEC DRILLING EQUIPMENTS PVT. LTD.
Plot No. 20, Shahpur Khurd, Seekri Distt-
Faridabad, Haryana
India

the right to use the Official API Monogram[®] on manufactured products under the conditions in the official publications of the American Petroleum Institute entitled API Spec Q1[®] and API-5CT and in accordance with the provisions of the License Agreement.

In all cases where the Official API Monogram is applied, the API Monogram shall be used in conjunction with this certificate number: 5CT-1666

The American Petroleum Institute reserves the right to revoke this authorization to use the Official API Monogram for any reason satisfactory to the Board of Directors of the American Petroleum Institute.

The scope of this license includes the following: Manufacturer of Accessories Group 1, J55/PSL 1, K55/PSL 1 and N80(1)/PSL 4 Group 2, L80(1)/PSL 1

QMS Exclusions: Servicing

Effective Date: JANUARY 25, 2018
Expiration Date: MAY 12, 2020

Executive Vice President

To verify the authenticity of this license, go to www.api.org/compositelst.

Certificate of Authority to use the Official API Monogram
License Number: 10D-0047 **ORIGINAL**

The American Petroleum Institute hereby grants to

OILMEC DRILLING EQUIPMENTS PVT. LTD.
Plot No. 20, Shahpur Khurd, Seekri Distt-
Faridabad, Haryana
India

the right to use the Official API Monogram[®] on manufactured products under the conditions in the official publications of the American Petroleum Institute entitled API Spec Q1[®] and API-10D and in accordance with the provisions of the License Agreement.

In all cases where the Official API Monogram is applied, the API Monogram shall be used in conjunction with this certificate number: 10D-0047

The American Petroleum Institute reserves the right to revoke this authorization to use the Official API Monogram for any reason satisfactory to the Board of Directors of the American Petroleum Institute.

The scope of this license includes the following: **Design Centralizers**

QMS Exclusions: Servicing

Effective Date: JANUARY 25, 2018
Expiration Date: MAY 12, 2020

Executive Vice President

To verify the authenticity of this license, go to www.api.org/compositelst.



REAMER & GUIDE SHOES



Prob-O-Tor™ Reamer Shoe (OM104-RS-POT)

The Oilmec Prob-O-Tor Reamer Shoe has been specifically designed to aid with the installation of any Casing, Liner or Screen application, where the operator has concerns over potentially difficult wellbore conditions such as swelling shale's, ledges and washed out areas within the wellbore.



Features

- ◆ Casing friendly tungsten carbide cutting structure
- ◆ Anti-aggressive left hand blades minimize torque
- ◆ 360° cutting structure facilitates reaming past obstructions with or without rotation
- ◆ Well-bore seeking eccentric guide nose negotiates troublesome formations
- ◆ aluminium guide nose to aid drill out without compromising nose strength
- ◆ Flow ports offering 360° flow area
- ◆ Slick body design helps reduce ECD

Options

- ◆ Single & double valve system available
- ◆ Autofill system available
- ◆ 5,000 & 10,000 PSI valves
- ◆ Concentric or other nose options available
- ◆ All API and premium connections available
- ◆ All material casing grades available



Reamer Shoe (OM104-RS)

- ◆ Designed for Problematic wells where reciprocation and/or rotation Of the casing is anticipated to ream the hole and land the Casing to total depth (TD)
- ◆ Features the valve API III-C rating.
- ◆ Standard features include aluminum eccentric nose and down-jets.
- ◆ Blade are coated with cutting structure is tungsten carbide with height Customized for hole size.



Guide Shoe (103-GS)

- ◆ Nose Orifice is sufficiently large as to allow conversion balls, tubes, and debris to exist the casing without obstruction.
- ◆ Round nose assists running casing in hole.
- ◆ Load bearing capability for setting casing on bottom.

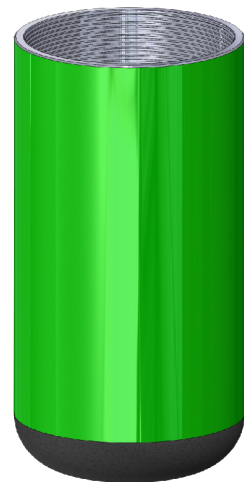

NOSE DESIGN & OPTIONS

Eccentric Nose

- ◆ The Eccentric Nose design assists running the casing/ liner past well bore obstructions with or without rotation. Typically used in primary cementing applications. Can be manufactured in both Aluminum and Phenolic materials



Concentric Nose

- ◆ The Concentric Nose assists running casing/liner in difficult well bore Conditions by path finding over and around swelling formations. Can be manufactured in both Aluminium and Phenolic materials



Spade Nose

- ◆ The Spade Nose is specifically designed for use on less demanding liner applications where only a setting sleeve is run, the spade nose assists running tool released. When set on bottom the spade nose shoe anchors the liner against the formation allowing the running tool to be rotated to release from the liner.





Float Equipments & Cementing Stage Tools



FLOAT SHOE OM101

The cement filled Float Shoe is fitted with Oilmec's API RP 10F CAT IIIC qualified valve as standard, the shoe can be ordered with single, double valve options

Features

- ◆ Tough durable profiled cement nose
- ◆ Tightly controlled cementing process for valve installation
- ◆ Cement tested for compressive strength & pressure retention
- ◆ Fitted with high flow phenolic Float Valve tested in accordance with API RP 10F CAT IIIC test procedures

Options

- ◆ Up/Down/side ports
- ◆ Standard 5,000 & high pressure 10,000 PSI valves
- ◆ Single, double & auto-fill valve options
- ◆ Ball deflector / ball catcher options



FLOAT COLLARS OM102

The cement filled Float Collar is fitted with Oilmec's API RP 10F CAT IIIC qualified valve as standard, the collar can be ordered with single, double Valve.

Features

- ◆ Fitted with high flow phenolic Float Valve tested in accordance with API RP 10F CAT IIIC test procedures
- ◆ Tightly controlled cementing process for valve installation
- ◆ Cement tested for compressive strength & pressure retention
- ◆ In-house manufacturing capabilities at global manufacturing facilities

Options

- ◆ Standard 5,000 & high pressure 10,000 PSI valves
- ◆ Single & double valves available
- ◆ Auto-fill option available
- ◆ Ball deflector / ball catcher options

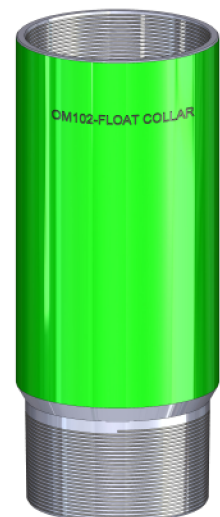

Non Rotating Float Collar OM102-NR

The Non rotating Float Collar is fitted with Oilmec's API RP 10F CAT IIIC qualified valve with Non Rotating insert the collar can be ordered with single, double Valve.

Features

- ◆ Fitted with high flow phenolic Float Valve tested in accordance with API RP 10F CAT IIIC test procedures
- ◆ Complete with Non-rotating insert to be compatible with Oilmec Non-Rotating Plugs only.
- ◆ Tightly controlled cementing process for valve installation
- ◆ Cement tested for compressive strength & pressure retention
- ◆ In-house manufacturing capabilities at global manufacturing facilities

Options

- ◆ Standard 5,000 & high pressure 10,000 PSI valves
- ◆ Single & double valves available
- ◆ Auto-fill option available
- ◆ Ball deflector / ball catcher options

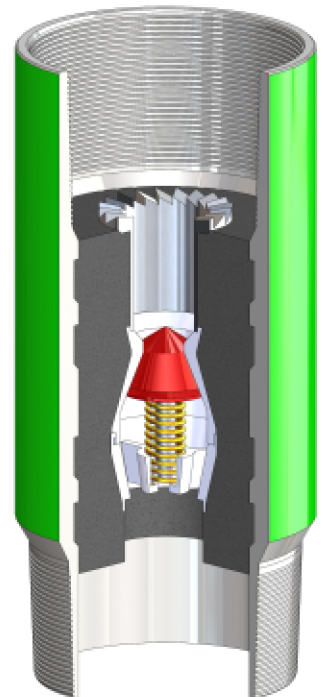

Auto Fill Float Shoe/Collar OM101-AF/OM102-AF

- ◆ Single Flapper valve design.
- ◆ Valve is run in hole open allowing the casing to completely fill.
- ◆ Converted to conventional one-way check valve by dropping a ball and pressuring up to the release the flapper.
- ◆ Until the conversion ball has been dropped, the casing can be circulated at any time without affecting the fill up operation.

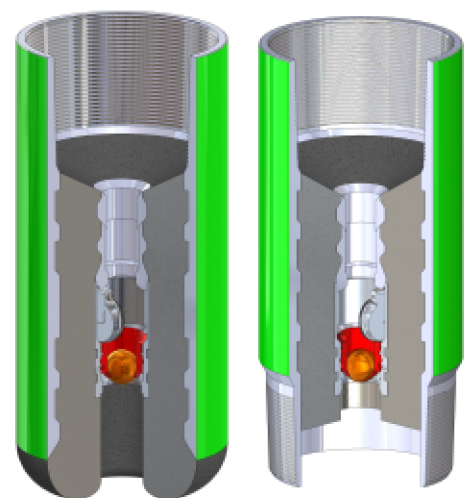

Differential Float Shoe/ Collar OM101-DF/OM102-DF

- ◆ Operation of the valve is controlled by the differential pressure across the valve assembly.
- ◆ Converted to conventional one-way check valve by dropping a ball and pressuring upto release the upper flapper and lock the lower sleeve.
- ◆ Until the conversion ball has been dropped, the casing can be circulated at any time without affecting the fill up operation

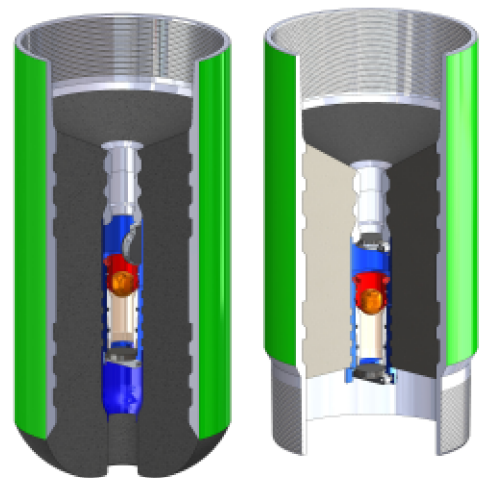

Stab In Float Shoe/Collar OM101-SI/OM102-SI

- ◆ Utilized for most inner string cementing applications.
- ◆ Recommended where reciprocation of the casing is not required during circulation.
- ◆ Recommended for use with Latch Down Drill Pipe Wiper Plug.
- ◆ OM020 –IF stab in stinger required.
- ◆ PDC drillable

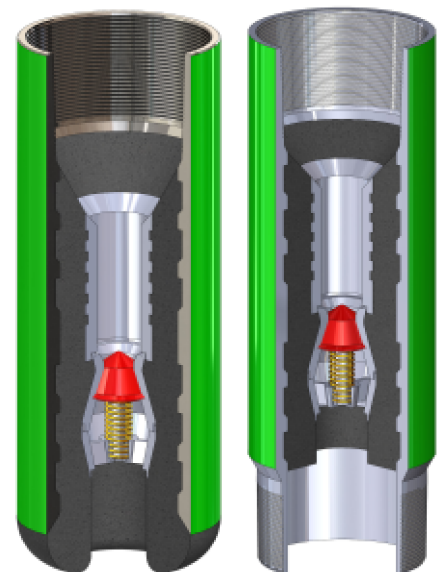



Stab In Stinger OM020

- ◆ Stung into the float Equipment by lowering directly into the receptacle.
- ◆ No Rotating is required.
- ◆ Stinger is removed by picking up on the drill string.
- ◆ Manufactured to connect to drill pipe size and thread.

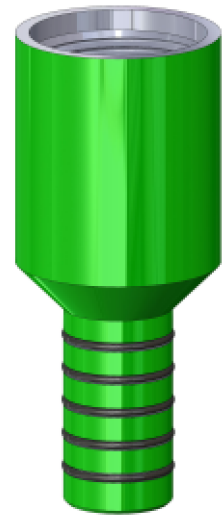

Drill Pipe Plugs OM- DART-SI

- ◆ Designed for use with type OM020 stingers.
- ◆ Offered in sizes to wipe 4 ½", 5" and 5 ½" drill pipe.
- ◆ Nose features an aluminum snap ring to latch into plate installed in the float equipment.
- ◆ PDC Drillable

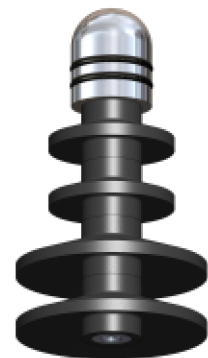

Stab in Latch in Float shoe/ Collar/ OM101-SIL/ OM102-SIL

- ◆ Receptacle has left hand threads to loc the stinger in to the float Equipment.
- ◆ Drill pipe and stinger can be easily backed out of the float equipment receptacle when cement job is complete.
- ◆ Recommended where reciprocation of the casing is required.
- ◆ Recommended for use with our Latch down wiper plugs.
- ◆ Oilmec Stab in Latch in Stinger required.

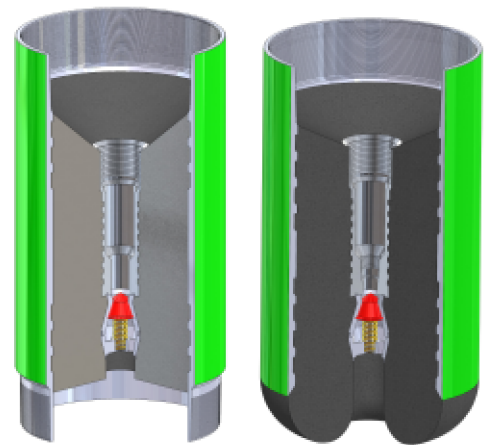

Stab in Latch in Stinger OM020-SIL

- ◆ Stung into the float equipment by lowering directly into the receptacle with left hand threads to lock the stinger in during cementing operations.
- ◆ Stinger is removed by picking up on the drill pipe size and thread.
- ◆ Recommended when the casing will be reciprocated during cementing.



Latch Down drill Pipe Plugs OM-SIL- DART

- ◆ Designed for use with type OM020 SIL stingers.
- ◆ Offered in sizes to wipe 4 ½", 5" and 5 ½" drill pipe.
- ◆ Nose features an aluminium snap ring to latch into plate installed in the float equipment.
- ◆ PDC Drillable



Hydraulic Stage Tool (OM107-H)

Oilmech's hydraulic stage tool meets the challenges of cementing holes at any angle with a hydraulically opened port system. stage tool designed specifically for horizontal completion. It is specifically used for Primary cementing in deep vertical or high deviated horizontal-well conditions. It reduces total hydrostatic pressure on weak formations to prevent lost circulation during cementing. Clear surface indications of opening and closing pressures provide safer and more efficient operations. The opening pressure of the stage tool can be adjusted at rig site to meet well requirements, providing operational flexibility.

- ◆ Designed for hydraulic operation with mechanical back-up.
- ◆ Snap ring design provides robust locking mechanism.
- ◆ Shifting pressure is accurate within +/- 10%.
- ◆ Externally set shear screws for field adjustable shifting pressure (for hydraulic only).
- ◆ All internal components are fully PDC or Tri-cone drillable.
- ◆ Standard tools are available in API L-80 /K-55 and P-110 grade materials.
- ◆ Standard seals rated for - 15°F to + 400°F and suitable for sour service

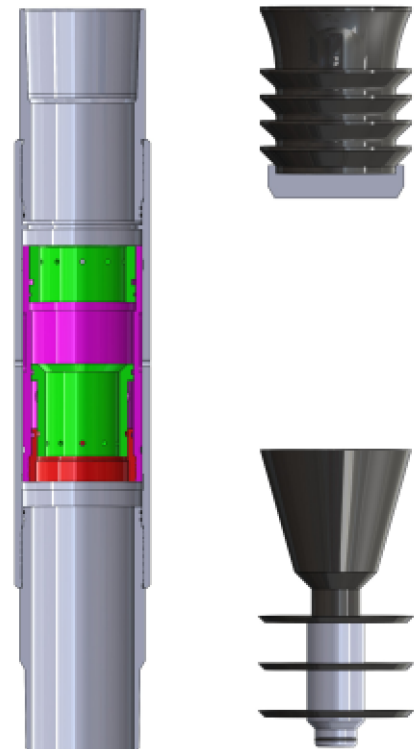

Mechanical Stage Tools (OM107-M)

Oilmec's Mechanical Stage Collar has been designed for stage cementing operations that require the tool to be opened mechanically. The tool features two internal sleeves that shift during the stage cementing operations. The bottom sleeve is shifted open by dropping an opening dart and allowing it to set on the opening seat. Closing the stage collar is achieved by pumping a closing plug behind the second stage cement and applying pressure upon completing displacement.

Field adjustable opening pressures.

- ◆ PDC drillable.
- ◆ Standard tools are furnished with L-80 material suitable for sour gas service.
- ◆ Standard seals are rated for -15°F to $+400^{\circ}\text{F}$ and suitable for sour service and high pressure gas environments.
- ◆ Compatible with most annular casing packers.
- ◆ Robust lock ring design prevents sleeves shifting prematurely.





CEMENTING PLUGS



CEMENT PLUGS

Cementing Plugs

Oilmec's Cementing Plugs are used during Cementing Operations for wiping the casing ID clean of Drilling Fluids and providing separation between, mud, spacers, and cement, They also prevent over displacement of the cement slurry and indicate when the cementing job is complete. Oilmec's Cementing Plugs have phenolic & Aluminum core to be drilled with PDC drill bits.

Conventional Top & Bottom Cementing Plugs OM105-T/OM105-B

Oilmec's Conventional Top & Bottom Cementing Plugs are available in Phenolic plastic core & Aluminum core with molded wiping fins from rubber. Cores are manufactured from phenolic material and cast aluminum. Oilmec offers phenolic core up to 13 3/8" Size and Aluminum core from 16" to 20". Above 20" Sizes available on customer requested. Oilmec Cementing Plugs are PDC Drillable.

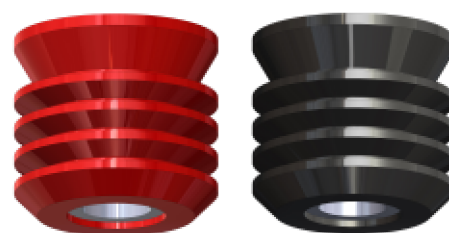

Non-Rotating Top & Bottom Cementing Plugs OM106-T/OM106-B

Oilmec's Non-Rotating Top & Bottom Cementing Plugs are available in Phenolic plastic core & Aluminum core with molded wiping fins from rubber with Non Rotating Insert. It is designed to prevent rotation of the plugs during drill out operations. Oilmec's Non Rotating Float Collar require with Oilmec Non Rotating plugs. Cores are manufactured from phenolic material and cast aluminum. Oilmec offers phenolic core up to 13 3/8" Size and Aluminum core from 16" to 20". Above 20" Sizes available on customer requested. Oilmec Cementing Plugs are PDC Drillable. We offer three different design as shown in pictures.

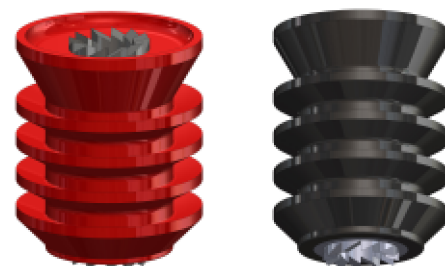

- ◆ Standard Non Rotating design
- ◆ Self Locking Design
- ◆ Teeth design





ZINC ALLOY SOLID BODY CENTRALIZER



Aluminum Alloy Straight Vane Solid Body Rigid Centralizer OMA-023-ST

Straight Vane solid rigid centralizer provide the right feature for getting a good primary cementing job with maximum wellbore standoff with suitable functionality. Straight vane solid rigid centralizers provide ultimate drag and torque reduction with maximum fluid by pass. Available in different material grades.

Features:-

- ◆ High axial load strength
- ◆ Construction provides superior toughness
- ◆ Units can be run between casing and less demanding wells



Aluminum Alloy Spiral Vane Solid Body Rigid Centralizer OMA-023-RH

This centralizer is made of high-strength, corrosion-resistant cast aluminum. They can be used with corrosion-resistant alloy casing strings to avoid the effects of galvanic corrosion. Their spiral blades fully overlap to give 100% wellbore coverage and increase annular turbulence to improve wellbore cleanout.

Features:-

- ◆ The centralizer provides positive standoff in the wellbore, enabling cement to be evenly distributed around the casing string.
- ◆ The 45° spiral blades provide increased velocity with a turbulent motion that optimizes mud and cement displacement, which maximizes the likelihood of achieving zonal isolation with primary cementation and minimizes the need for remedial cementing operations.



Zinc Alloy Straight Vane Solid Body Rigid Centralizer OMZ-023-ST

Straight Vane solid rigid centralizer provide the right feature for getting a good primary cementing job with maximum wellbore standoff with suitable functionality. Straight vane solid rigid centralizers provide ultimate drag and torque reduction with maximum fluid by pass. Available in different material grades

Features:-

- ◆ High axial load strength
- ◆ Construction provides superior toughness
- ◆ Units can be run between casing and less demanding wells



Zinc Alloy Spiral Vane Solid Body Rigid Centralizer OMZ-023-RH

Zinc alloy, solid blade centralizer designed to aid casing running by reducing drag through the cased hole section and promoting good cement placement by torque reduction to allow rotation while cementing. The blade design will create turbulence as cement is pumped into the annulus promoting 360° cement coverage.

Features:-

- ◆ High strength - allowing thinner wall-sections giving maximum flow-by
- ◆ Exceptional wear resistance - maximum standoff
- ◆ Low friction - reducing torque & drag
- ◆ Withstands temperatures up to 400°



Casted Steel Spiral Vane Solid Body Rigid Centralizer OM-S-023

This is a heavy duty one piece cast steel centralizer offering a cost effective reliable solution. Spiral Vane solid rigid centralizer provide the right feature for getting a good primary cementing job with maximum wellbore standoff with suitable functionality. Straight vane solid rigid centralizers provide ultimate drag and torque reduction with maximum fluid by pass. Available in different material grades

Features

- ◆ Heavy duty / high impact
- ◆ Positive stand-off
- ◆ Torque & drag reduction
- ◆ Maximum flow by
- ◆ Suitable for HPHT applications

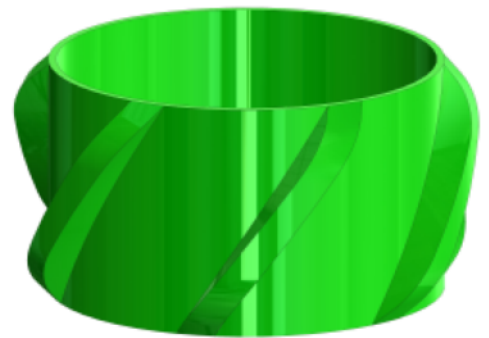

Steel Welded Spiral Vane Solid Body Rigid Centralizer OM-SW-023

Silp on welded design allows for direct installation over the casing in between stop collars of casing collar. Recommended for horizontal and extended reach wells where higher strength is required of when rotation is required to install casing. Available in left right or straight vane orientation. Also available with set screw



Slip on Welded Heavy Duty Positive Spirolizer – OM013

- ◆ Features hollow steel blades with a rounded smooth profile
- ◆ All steel design can withstand severe wellbore conditions.
- ◆ Can be used in well where casing reciprocation and/or rotation is required.
- ◆ Available with or without set screws.
- ◆ Available in right or straight vane orientation.

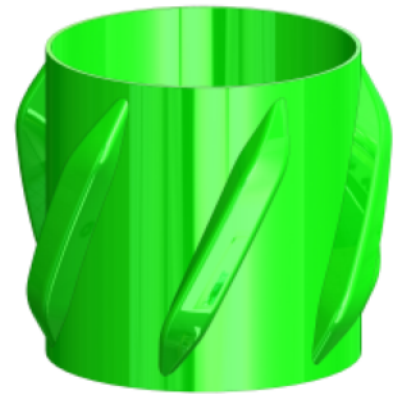

Slip on Welded Heavy Duty Straight Bow Spirolizer – OM014

- ◆ Features hollow steel blades with a rounded smooth profile
- ◆ All steel design can withstand severe wellbore conditions.
- ◆ Can be used in well where casing reciprocation and/or rotation is required.
- ◆ Available with or without set screws.
- ◆ Available in right or straight vane orientation.

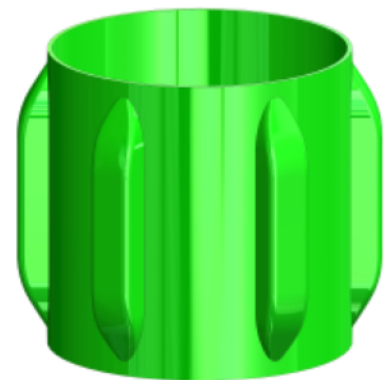

Roller Centralizers – OM 016

Centralizers rollers are fixed on centralizer vanes such that the axis of rollers. The roller outer diameter is slightly larger than centralizer body outer dia. Rollers are capable enough to reduce considerable drag force due to low friction coefficient between well and centralizer. The small contact area of the rollers with the casing or borehole wall functions exceptionally well in under pressured conditions, where risk of differential sticking is high. High quality material provides excellent high temperature high-pressure performance and corrosion resistance, reducing the cost of replacement.

Roller centralizers are mainly used for big high Roller, high deviated wells and horizontal wells, to centre casings. Roller Centralizers can also remove wellbore cake and improve mud replacement efficiency etc. Roller Centralizers provide superior wear resistance and have been proven to remain functional throughout the life of the well and can aid in casing/tubing retrieval.

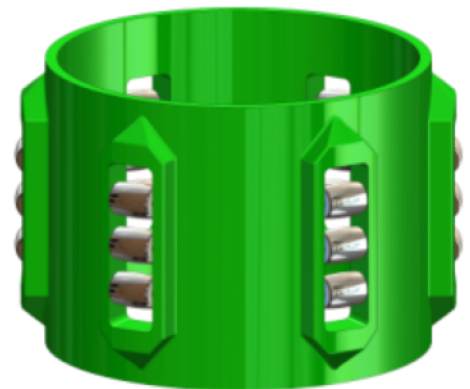

Slip on Welded Positive Spirolizer – OM012

Oilmec's Slip on Welded Positive Spirolizers are made from super strength tensile steel. The bows of these Spirolizer are made to provide extreme restoring forces under Lateral Loads. Each Bow has high quality weld which enables high performance in horizontal demanding wells. The bows of these centralizers has a unique design "boat shape" which makes them perfectly apt for the present day deviated wellbores. The Powder coating in the final process which gives the product a smooth finish and insures stocking in the open for a long time.



Hinged Non Welded Bow Spring Centralizer OM001

The Standard 'Bow Spring' range are hinged non-welded bow-spring centralizers designed to centralize in less demanding well-bore applications where rotation is not a requirement. The hinge allows the centralizer to be fitted on larger bore casing where weld on connectors do not allow for a slip-on unit to be installed .

Features

- ◆ API certified - engineered and tested to exceed API 10 D
- ◆ Low insertion & running forces
- ◆ High restoring forces
- ◆ Suitable for passing through wellbore / cased hole restrictions
- ◆ High quality spring steel grade

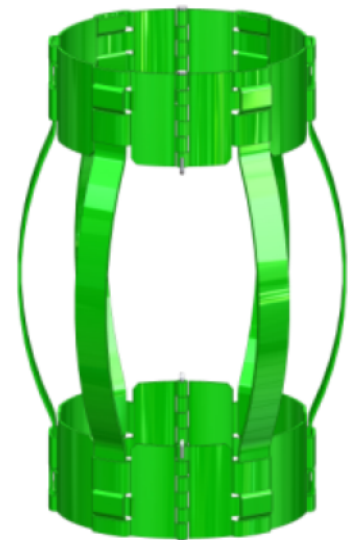

Hinged Non Welded Stainless Steel Bow Spring Centralizer OM001-SS

Stainless Steel centralizers are special purpose centralizers it's used where the chances of corrosion and contamination are present, or it can be used for water well also. It's a 100% stainless Steel Manufacturing along with stainless steel nails Premium Quality Bows are made of stainless steel material and hot formed in totally controlled Heat Treatment Plant to achieve the uniform hardness all over and good spring back action

Features and Benefits

- ◆ Extended profile prevents them from hitting against casing collars.
- ◆ These can be shipped in half assembled condition for economy in freight and storage costs
- ◆ Five standard size Bows can be configured to any hole diameter.
- ◆ Supplied with stop collar and hinge pin





STANDARD CASING BOW CENTRALIZER



Hinged Welded Bow Spring Centralizer OM002

- ◆ Provides Uniform Annular clearance and is suited for vertical & deviated application.
- ◆ Minimizes Different Sticking.
- ◆ Can be rotated or reciprocated with the casing.



Hinged Welded Drill Pipe Centralizer OM002-DP

Drill Pipe Centralizer has been designed specifically for centering drill pipe or tubing within larger size casing. Typical applications would include stab-in cementing operations.

Performance Features:

- ◆ Hinged design for installation on drill pipe.
- ◆ bow springs made from heat treated material for optimized pipe centering within casing.
- ◆ Provides stand-off to drill pipe/tubing to prevent possibly hang up during run in.
- ◆ Help guide stinger into receptacle for stab-in cementing operations.

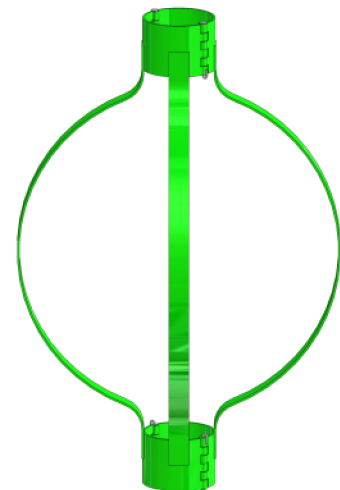

Hinged Non Welded Bow Spring Turbolizer OM004

Non Welded Turbolizer has deflector blade fitted on standard bow spring which creates difference from the standard centralizers. These blades or Fins are specially made of Heat Treated spring steel. The metal fins are installed on the Bows, to help induce turbulence in the cement slurry during pumping operation. Spring action of blades makes them flexible, which minimize damage while moving downhole.

Features:-

- ◆ Device improves the cleaning action of Drilling Fluids. Distribute the cement slurry into Well bore irregularities and minimizes channeling.
- ◆ Special Iron Phosphate coating process to prevent from Rust and insures stocking in the open for a long time.
- ◆ These are shipped in half assembled condition for economical in freight and storage costs
- ◆ Supplied with stop collar and hinge pin



Hinged Welded Bow Spring Turbolizer OM005

Welded Turbolizer has deflector blade fitted on standard bow spring which creates difference from the standard centralizers. The End Collars are designed with a reinforcing Rib stamped into the End Collar to give maximum structural toughness Another special characteristic is built in Stop device on leading End Collar. The metal fins are installed on the bows, to help induce turbulence in the cement slurry during pumping operation. Spring action of blades makes them flexible, which minimize damage while moving downhole.

Features:-

- ◆ Device improves the cleaning action of Drilling Fluids. Distribute the cement slurry into Well bore irregularities and minimizes channeling.
- ◆ Special Iron Phosphate coating process to prevent from Rust and insures stocking in the open for a long time.
- ◆ These are shipped in half assembled condition for economical in freight and storage costs
- ◆ Supplied with stop collar and hinge pin

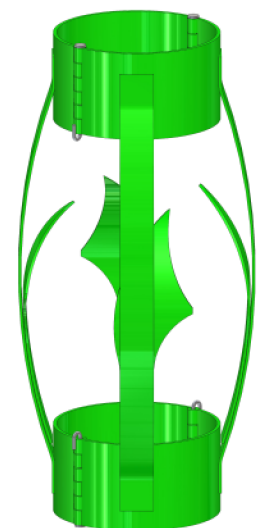

Slip on welded Bow Spring Centralizer OM003

- ◆ Notched Collar design allows for a smaller minimum compressed OD of the bows required in close tolerance applications.
- ◆ Recommended for use with Slip on set screw Stop Collars.
- ◆ Also available with integral set screws on stop collar.



Slip on Welded Single Piece Bow Spring Centralizer – Oilmec Crown OM003-C

Single Piece Slip on Welded Bow Spring Centralizer is called Our Oilmec Crown. Its integral design provides a more robust product by eliminating the possibility of weld failures at the bows.

Its one-piece design provides higher restoring forces while maintaining flexibility, ultimately increasing stand-off. With higher restoring forces and lower running forces, the Oilmec Crown can be used in vertical and horizontal hole inclinations.



Slip on Welded Bow Spring Turbolizer OM006

Slip on Welded Turbolizer has deflector blade fitted on standard bow spring which creates difference from the standard centralizers. These blades or Fins are specially made of Heat Treated spring steel. The metal fins are installed on the Bows, to help induce turbulence in the cement slurry during pumping operation. Spring action of blades makes them flexible, which minimize damage while moving downhole. Collars are specially designed with roll formed peripheral ridges which provide extra rigidity. Slips On Turbolizers are provided for direct installation on pipe by slipping on and can be provided with Setscrew for elimination of Stop collar.

Features :-

- ◆ Device improves the cleaning action of Drilling Fluids. Distribute the cement slurry into Well bore irregularities and minimizes channeling.
- ◆ Special Iron Phosphate coating process to prevent from Rust and insures stocking in the open for a long time.

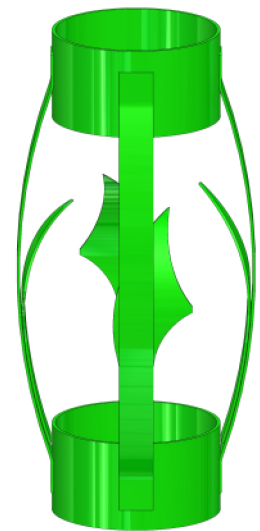

Hinged Non Welded Positive Rigid Centralizer OM008

Specially designed flat-bottomed U shaped blades are provided for maximum fluid flow by and required rigidity, the blade form also cuts down on RIH drag due to less surface area contact with the previous casing string it is being run through.

Features:-

- ◆ Special Iron Phosphate coating process to prevent from Rust and insures stocking in the open for a long time.
- ◆ These are shipped in half assembled condition for economical in freight and storage costs
- ◆ Supplied with stop collar and hinge pin

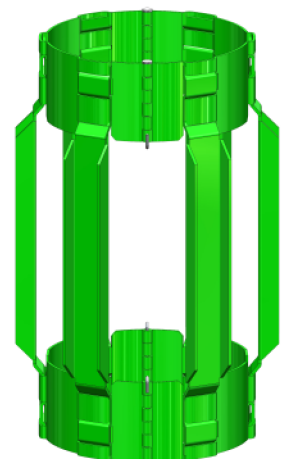

Hinged Non Welded Semi-Rigid Bow Centralizer OM009

Hinged Non Weld Semi-rigid bow centralizer withstands high lateral loads and is specially designed with a double bow profile, this design increases contact area for less bow penetration into the formation and aids in complete mud removal while cementing. Semi Rigid Centralizers have the ability to withstand high lateral load encountered. High efficiency in casing jobs on Deviated and Horizontal wells.

Features

- ◆ It has high Restoring force and high Stand Off with low running force.
- ◆ Special Iron Phosphate coating process to prevent from rust and insures stocking in the open for a long time.
- ◆ These are shipped in half assembled condition for economical in freight and storage costs.
- ◆ Supplied with stop collar and hinge pin.

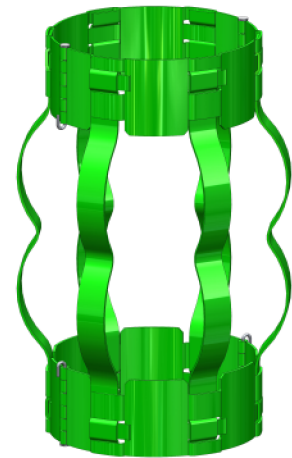

Hinged Welded Semi-Rigid Bow Centralizer OM010

Hinged Welded Semi Rigid Centralizer ensures high efficiency in casing. Welded Centralizer has more Restoring Force as compare to Non Weld Centralizer. The Centralizers have double crested Bow Spring strongly welded to the End Collar under required temperature

Features:

- ◆ It has high Restoring force and high Stand Off with low running force.
- ◆ Special Iron Phosphate coating process to prevent from Rust and insures stocking in the open for a long time.
- ◆ These are shipped in half assembled condition for economical in freight and storage costs.
- ◆ Supplied with stop collar and hinge pin.

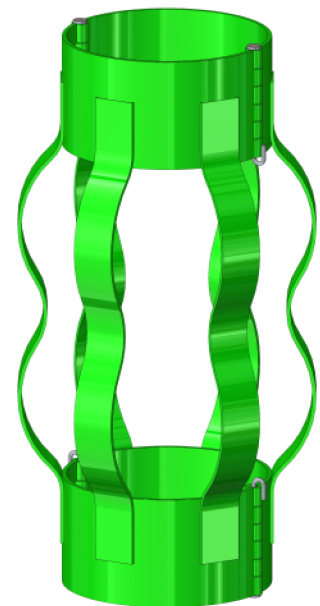

Slip on Welded Semi-Rigid Bow Centralizer OM011

Slip On Welded Semi-Rigid Centralizers share many of the same design and operational features as Hinged Welded Centralizers. They can be directly installed onto pipe and are provided with set screw style Stop Collars to increase the holding force. The Collars are innovatively designed with roll formed peripheral ridges that provide extra rigidity. The Centralizers are available in a variety of Bows configured from a choice of four standard Bow heights.

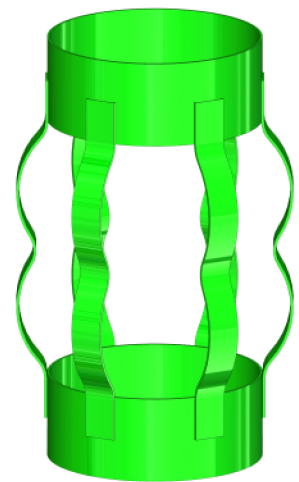

Slip on Welded Cement Basket – OM015

Cement baskets protect weak formations from hydrostatic pressures exerted by the weight of cement columns. Baskets are run above weak formations on casing, tubing, and liner strings and can be used in single stage or multistage cement jobs. Each basket is made of a high-strength metal and features overlapping fins to provide maximum flexibility and fluid passage while maintaining optimum support. Cement baskets are available in latch-on or slip-on configurations and should be installed over stop collars to prevent axial movement.





Hinged Welded Cement Basket OM015-HW

Hinged Welded Cement Basket is designed with Flexible Bow Springs, heat-treated under controlled conditions for maximum strength and uniformity are welded to slip-on collars and overlapping metal fins for flexibility and strength to support long columns of cement during primary cementing operations it is easily installed by sliding it over the pin end of a casing joint, prior to make-up of the joint.





STOP COLLARS



Hinged Spiral nails Stop collars OMSC001

- ◆ Utilizes two spiral locking pins which, when driven in firmly, lock the collar into position around the casing.
- ◆ Sizes less than 13 3/8" use 2 spiral locking nails
- ◆ Sizes 13 3/8" and greater use 4 spiral locking nails.
- ◆ Holding force meets, or exceeds API specification 10D-2

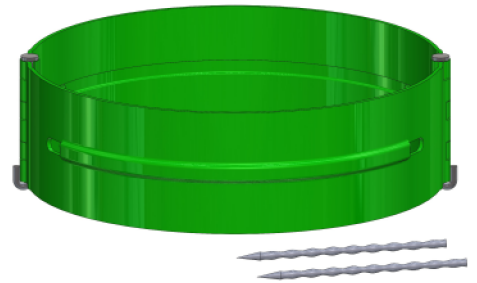

Hinged Bolted Stop Collar OMSC002

- ◆ Hinged Bolted Stop Collar is designed to latch-on to the casing without having to be slipped over the end of the casing allowing for quick and easy installation. The holding force of the Bolted Stop collar is higher than the allowable centralizer starting force as specified in AP1 Specification 10D. It uses a nut and bolt assembly which when tightened draws the stop collar into a friction grip around the circumference of the pipe. This design does not produce markings or indentations on the casing after installation.
- ◆ Bolt Lock Mechanism allows for quick and easy installation over casing.
- ◆ Holding force meets, or exceeds API Specification 10D-2

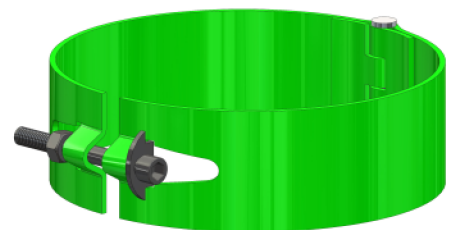

Hinged Set Screw Stop Collar OMSC003

Designed to be latched on to the casing with set screws providing additional holding force This Stop Collar Offers superior holding capability with easy to install features. Easy installan with Allen wrench utilized in most cased and open hole applications. Superior holding performance for most

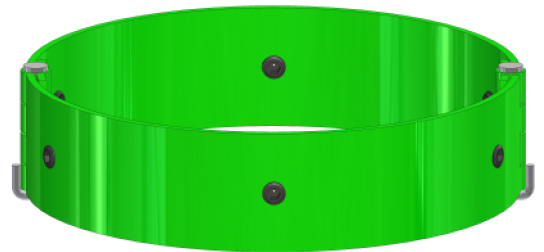

Slip on Set Screw Stop Collar OMSC004

- ◆ Installed with set screws.
- ◆ Designed for use where higher holding forces are required.
- ◆ Easy Installation that can be achieved using an Allen wrench.





SERVICES



Oilmec R&D are continually involved in designing and manufacturing products for customer specific applications utilizing many different materials and manufacturing techniques. We continue to introduce new innovative products to our expanding portfolio which already include the market leading Oil field casing & cementing accessories.

Oilmec collaborate with multiple manufacturing companies worldwide, and are experts in casting and moulding whether it be Sand casting, Gravity Die casting, Pressure Die casting or by the Lost Wax process in materials such as Zinc, Aluminium and Bronze Alloys, Thermoplastics and Ductile/SG Irons. We also design and manufacture components from machined Steel using the latest CNC machinery available. Steel fabrication work is also undertaken.



www.oilmecasia.com



Whatever your product requirements, OILMEC Products have the expertise to take any project from conception through to production, quickly & cost effectively.

OILMEC investment in 'cutting edge' technologies has cut down on our 'life cycle' design process. Our Design & Engineering Team utilize the very latest Computer Aided Design (CAD) software affording 3D dimensional modelling. This coupled with animation & simulation software enables us to prove new products prior to manufacture.

API 10D testing rigs for start and restoring force

Additional compression / load testing rigs to exceed API 10D

Lateral/end load testing on solid body centralizers and reamer/guide shoe products

Float equipment and valve pressure testing in accordance with API RP10F IIIC

Cement batch testing

Cable protector cable push/pull test rig

Stop collar testing facilities meeting API 10D II requirements.



www.oilmecasia.com



Our Manufacturing & Procurement Team liaise between Sales, Design, Engineering and the Manufacturing Subcontractors to ensure that finished products are made within specification and are available on time to meet customer requirements.

Oilmec boasts wide and varied testing capabilities at our global locations. We operate over 30 CNC lathes, milling machines and boring machines, producing float equipment and subs up to 20". With a highly skilled and experienced engineering team and machinists, we offer fast and innovative product solutions with a very short turn around time.



www.oilmecasia.com

Corporate Office:

Oilmec Drilling Equipments Pvt. Ltd.

Plot No. 20, Shahpur Khurd Village, Sikri, Faridabad, 121004, India

Tel: +91-9811085352 Email: cmd@oilmecasia.com, marketing@oilmecasia.com

Dubai Office :

Oilmec Drilling Equipment M.E.N.A FZC

PO Box 33964, Dubai, UAE